

ASSEMBLY AND INSTALLATION INSTRUCTIONS

T0208

WARNING: TO AVOID RISK OF ELECTRICAL SHOCK, BE SURE TO SHUT OFF POWER BEFORE INSTALLING OR SERVICING THIS FIXTURE.

NOTES: 1. Before installing, consult local electrical codes for wiring and grounding requirements.
2. READ AND SAVE THESE INSTRUCTIONS.

Hardware Package (included):

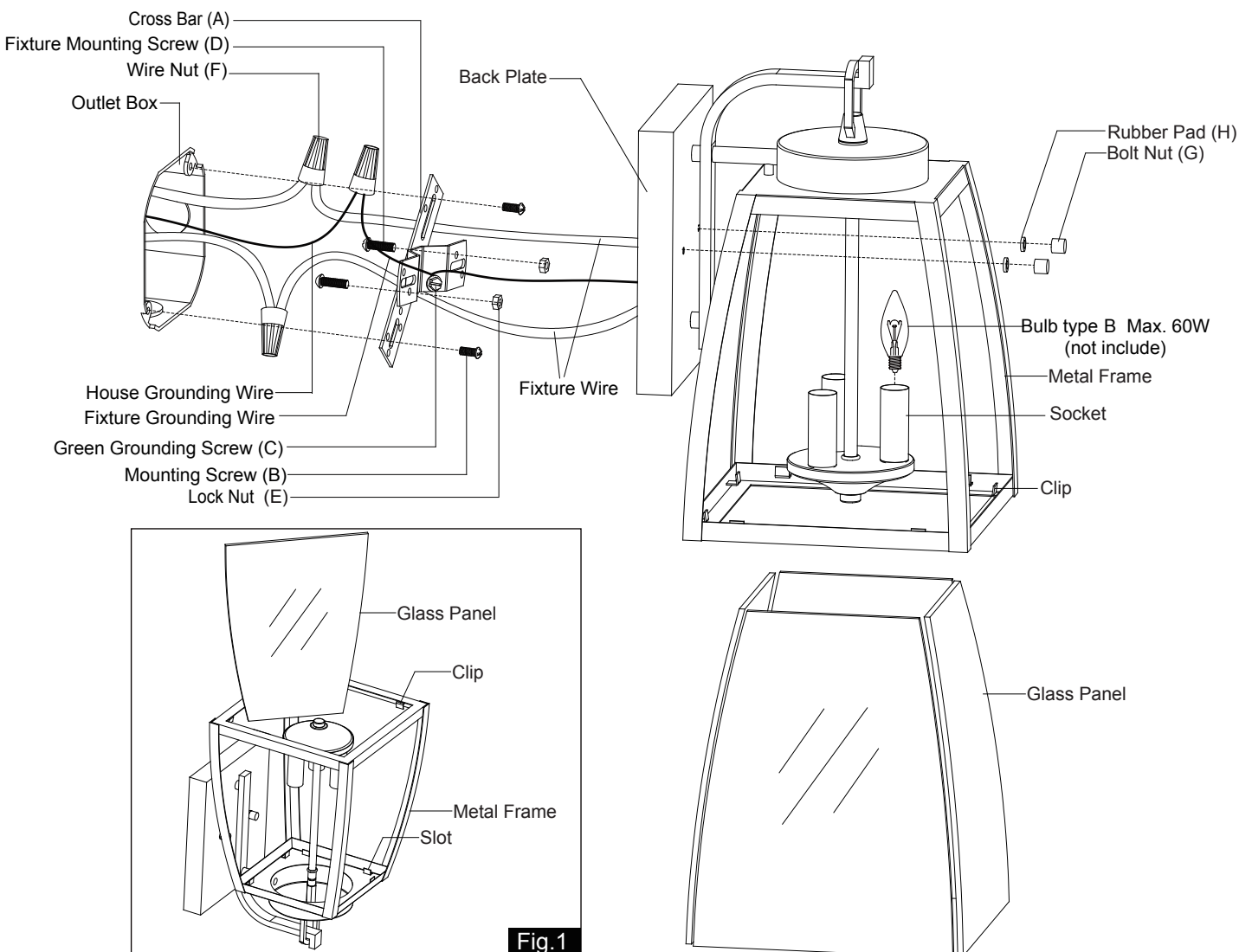
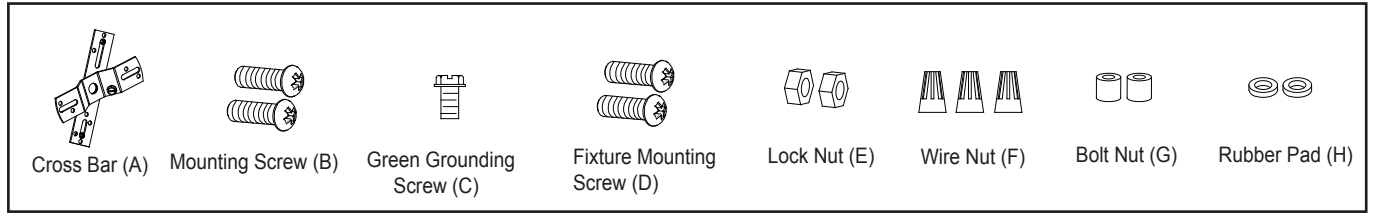

Installation Steps

Turn off the power at fuse or circuit box.

1. Thread two fixture mounting screws through the cross bar, and then secure them with two lock nuts. Adjust the length of the fixture mounting screws if necessary.

Note: Make sure that the fixture mounting screws are lined up horizontally to make the fixture level.







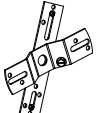

2. Attach cross bar to the outlet box using two mounting screws.
3. Take a glass panel, tilt and insert it into the slots at one side of the metal frame carefully, secure it by pressing the clips. Repeat with the other glass panels.(See Fig.1)
4. Pull out the source wires from the outlet box. Make wire connections using wire nuts as follows:
 - Connect the hot wire (usually black insulation) from the fixture to the black wire from the power source.
 - Connect the neutral wire (usually white insulation) from the fixture to the white wire from the power source.
 - Attach the fixture grounding wire (usually green insulation or bare wire) to the cross bar with the green grounding screw, and then connect it to the house grounding wire with the wire nut.
 Carefully put the wires back into the outlet box.
5. Attach the back plate to the cross bar by inserting two fixture mounting screws, and then secure it with two rubber pads and two bolt nuts.

NOTE: With silicone caulking compound, caulk completely around where the back plate meets with the wall surface to prevent water from seeping into the outlet box.
6. Install bulbs (not included). Check relamping label at socket area or packaging for maximum allowed wattage.

Turn on the power at fuse or circuit box

The following parts are available for re-order if damaged or missing.

Spare Parts List:

				← Assembly Kit 5479MM (1 SET)
Cross Bar (A)	Mounting Screw (B)	Green Grounding Screw (C)	Fixture Mounting Screw (D)	
				Glass Panel 9788C(4PCS)
Lock Nut (E)	Wire Nut (F)	Bolt Nut (G)	Rubber Pad (H)	

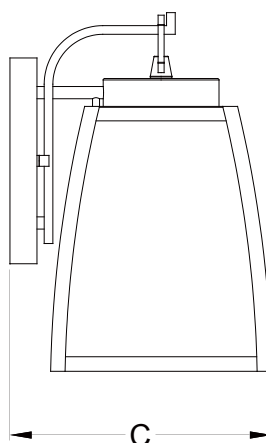
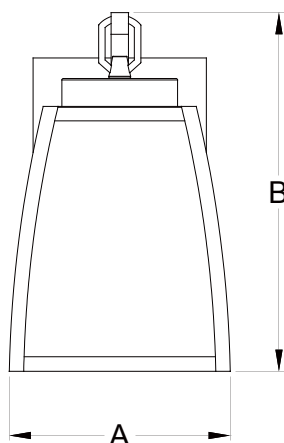

A: 10"

B: 16-1/2"

C: 11-5/8"